

Shut-off damper

DTU



Description

Has a turning circular blade with an EPDM-rubber seal which tightens against the inside of the damper when closed. The blade can be adjusted in a 0–90° angle.

The cup at Ø 80–630 can be complemented with the special insulation cup IK at insulation thicker than 50 mm.

The damper can be used for regulating at rare occasions.

There is a separate assembly, measuring, balancing and maintenance instruction for this product.

Ø 80–315 fullfills pressure class C in closed position.
 Ø 355–630 fullfills pressure class B in closed position.
 Ø 710–1000 fullfills pressure class A in closed position.

Motorizing

The torque needed for the motorizing is given in the adjacent table.

Ø710–1000 is not possible to motorize on site.

Reinforced blade



Ordering example

Product	DTU	200
Dimension Ød ₁		

Dimensions

Ø 80–630

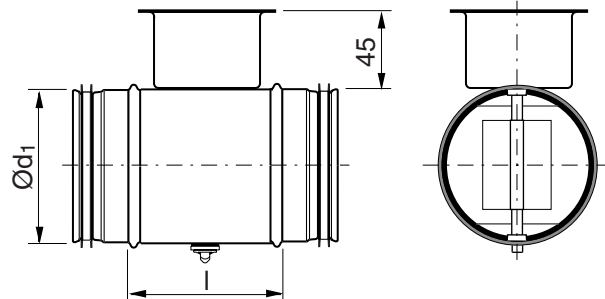

Ø 800–1000

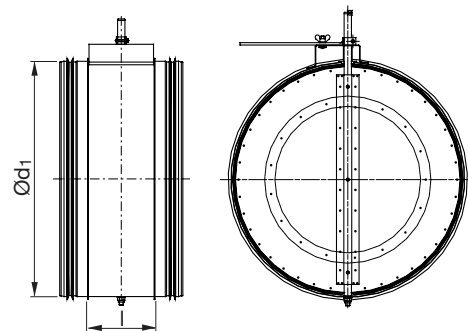

Ød ₁ nom	l mm	M Nm	m kg	Sealing class past closed blade
80	100	2,0	0,30	4
100	100	2,0	0,38	4
112	100	2,0	0,48	4
125	100	2,0	0,53	4
140	100	2,0	0,60	4
150	100	2,0	0,63	4
160	100	2,0	0,74	4
180	100	2,0	0,82	4
200	100	2,0	1,04	4
224	100	3,0	1,27	4
250	100	3,0	1,52	4
280	100	4,0	1,77	4
300	100	4,0	1,98	4
315	100	4,0	2,14	4
355	100	8,0	2,44	4
400	100	8,0	3,65	4
450	100	10	4,84	4
500	115	10	6,07	4
560	115	15	7,47	4
600	115	15	8,11	4
630	115	15	8,80	4
710	230	40	17,0	4
800	230	40	19,5	4
900	230	60	26,0	4
1000	230	60	31,0	4

Shut-off damper

- 1
- 2
- 3
- 4
- 5
- 6
- 7
- 8
- 9
- 10
- 11
- 12
- 13
- 14
- 15
- 16
- 17
- 18

Property	Ø 80-315	Ø 400	Ø 500	Ø 630	Ø 710-1000
The blade is set via a knob in a protective cup.	x	x	x	x	
The setting of the blade is read against an embossed scale at the rim of the cup.	x	x	x	x	
The blade is locked with two screws, type Pozidriv (PZD2).	x	x	x	x	
The blade has reinforced locking with a sturdy wing nut.					x
The blade is reinforced.		x	x	x	
The blade is additionally reinforced.					x
With sturdy handle.		x	x	x	
With additionally reinforced handle.					x
With reinforced stop beads.			x	x	x
The axle is reinforced.					x
The damper can be delivered prepared for motor. Is then called DTHU.	x	x	x	x	x
The damper can be delivered with electric motor of On/Off-type without spring return. Is then called DTBU.	x	x	x	x	x
The damper can be delivered with electric motor of On/Off-type with spring return. Is then called DTBCU.	x	x	x	x	
The damper can be delivered with pneumatic actuator of On/Off-type with spring return. Is then called DTPU.	x	x	x	x	

Technical data

Pressure drop graphs with noise data for dimensioning

The solid curves show the pressure drop, Δp_t , over the damper as a function of flow q , and setting angle α .

The dashed curves give the A-weighted sound power data, L_{WA} , in dB to the duct.

Example

Given Dimension Ø100
 Flow 60 l/s
 Pressure drop 200 Pa

Obtained from graph

Setting angle 32°
 Sound power level 63 dB (A)

Ø80

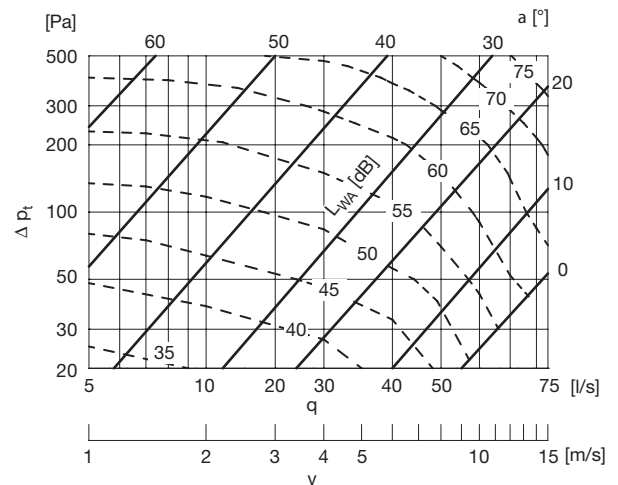

Ø100

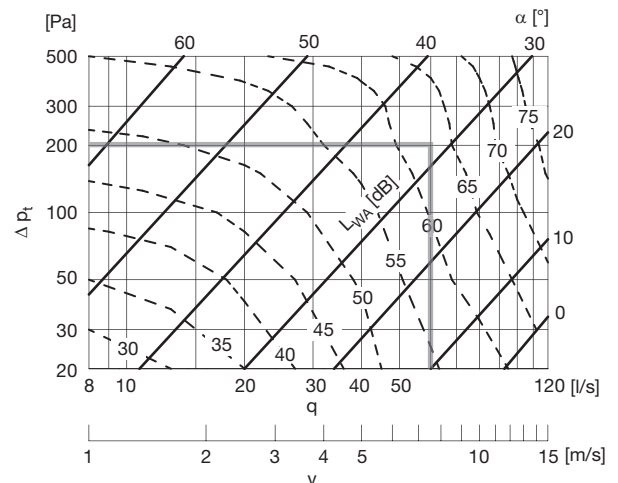

Shut-off damper

DTU

Ø112

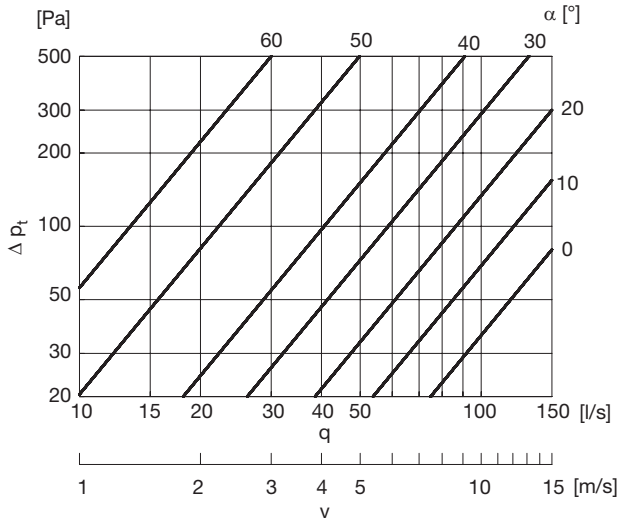

Ø150

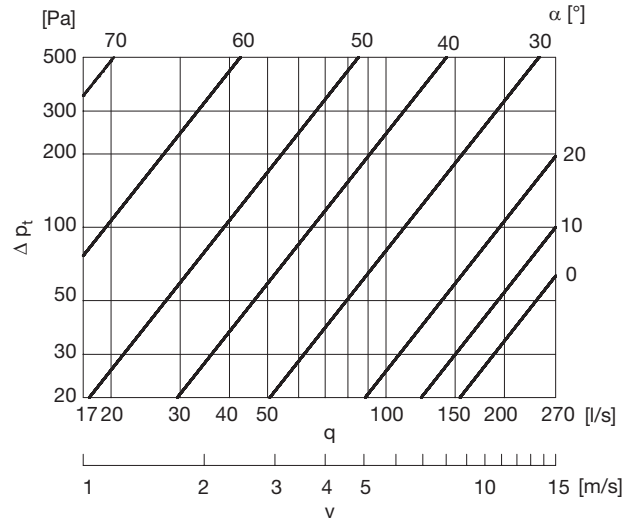

Ø125

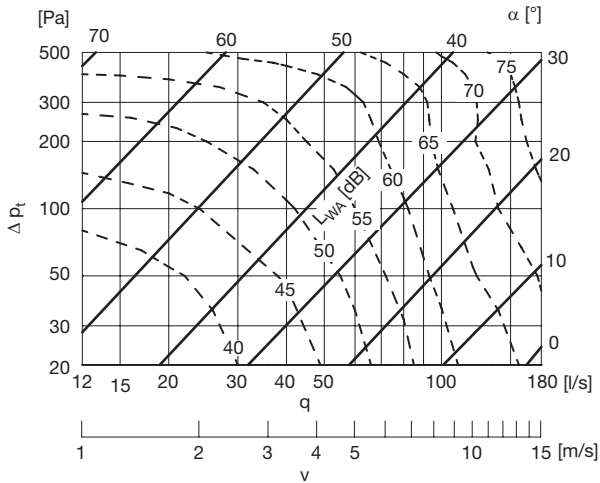

Ø160

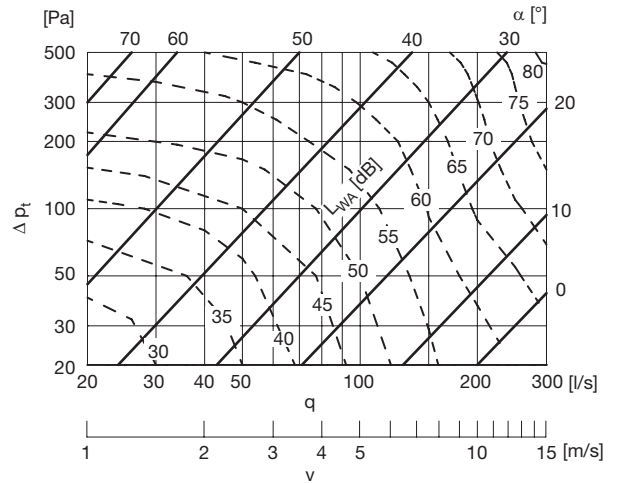

Ø140

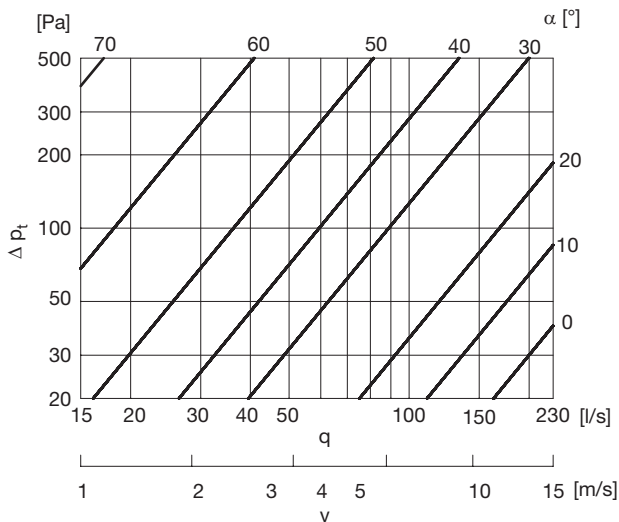

Ø180

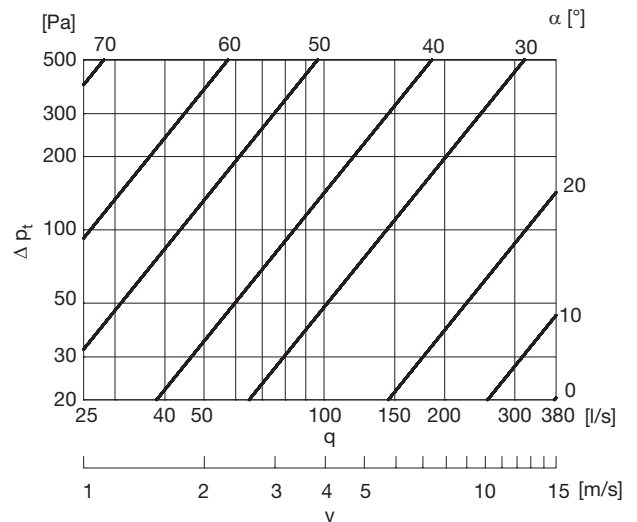

- 1
- 2
- 3
- 4
- 5
- 6
- 7
- 8
- 9
- 10
- 11
- 12
- 13
- 14
- 15
- 16
- 17
- 18

Shut-off damper

DTU

- 1
- 2
- 3
- 4
- 5
- 6
- 7
- 8
- 9
- 10
- 11
- 12
- 13
- 14
- 15
- 16
- 17
- 18

Ø200

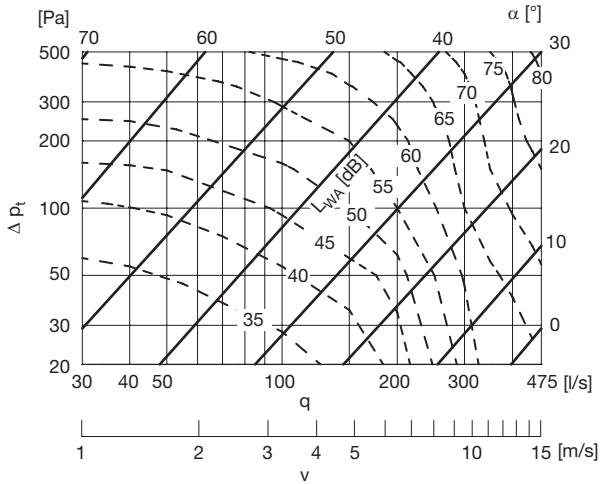

Ø280

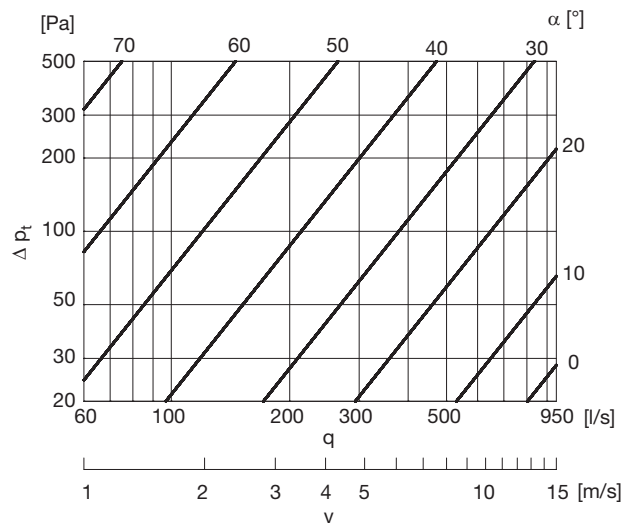

Ø224

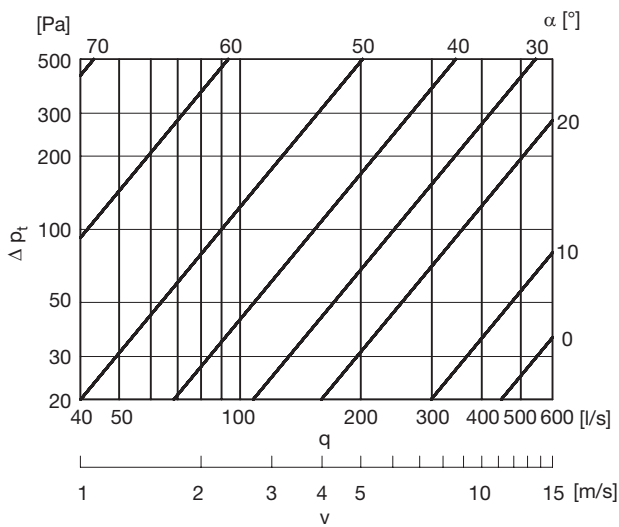

Ø300

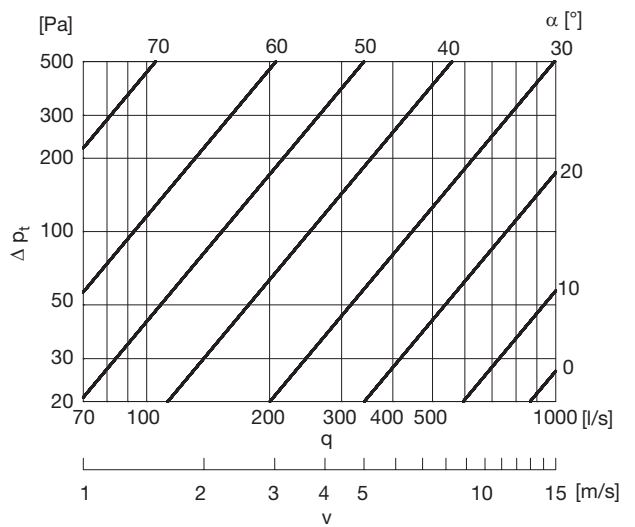

Ø250

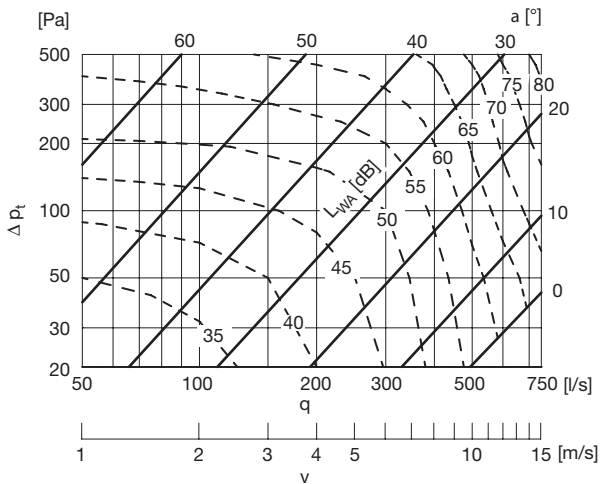

Ø315

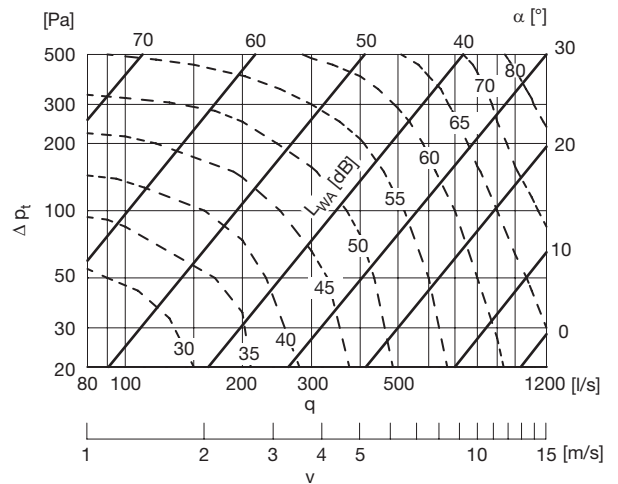

Shut-off damper

DTU

Ø355

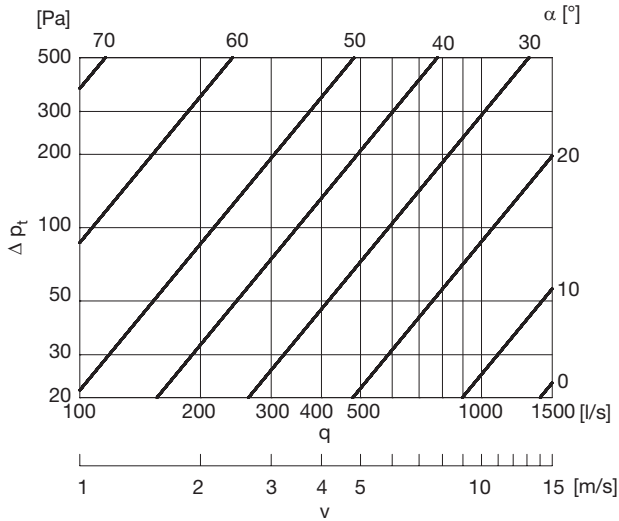

Ø500

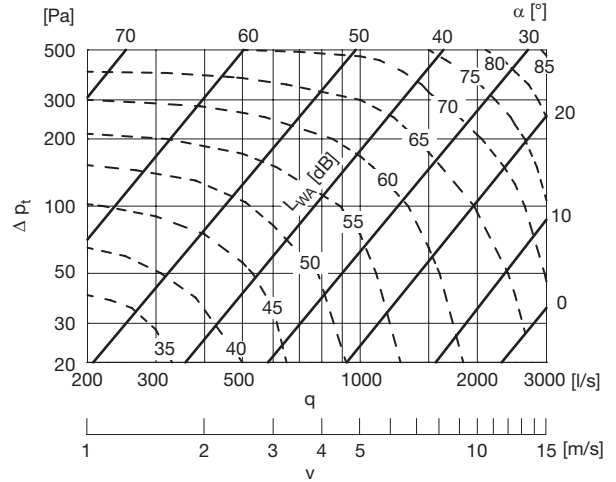

Ø400

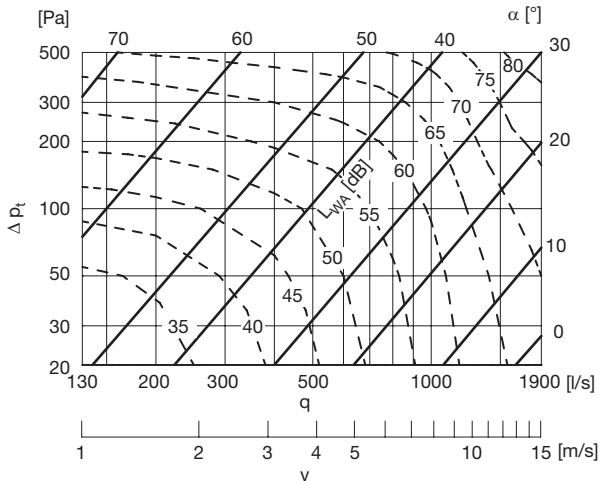

Ø560

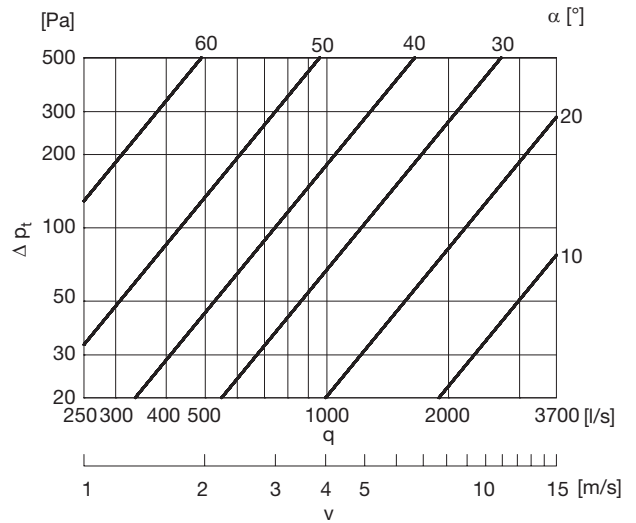

Ø450

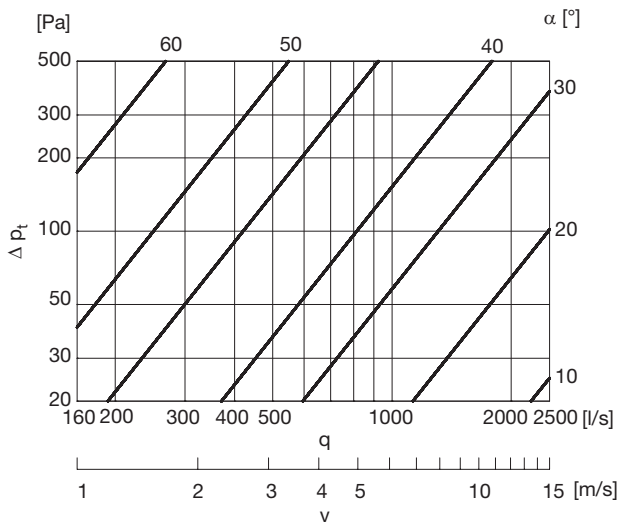

Ø600

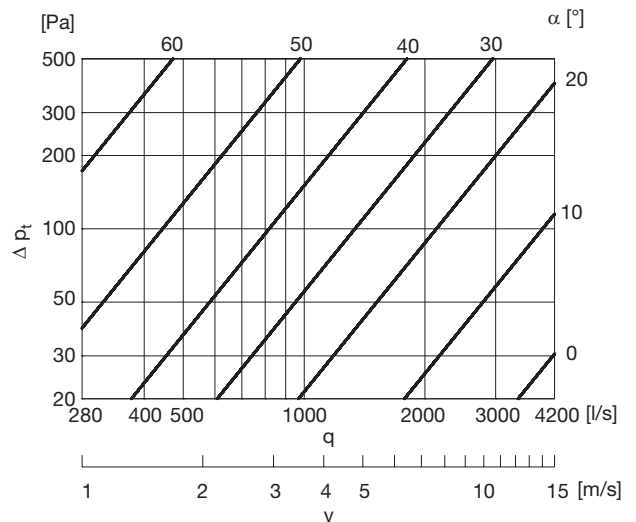

- 1
- 2
- 3
- 4
- 5
- 6
- 7
- 8
- 9
- 10
- 11
- 12
- 13
- 14
- 15
- 16
- 17
- 18

Shut-off damper

- 1
- 2
- 3
- 4
- 5
- 6
- 7
- 8
- 9
- 10
- 11
- 12
- 13
- 14
- 15
- 16
- 17
- 18

Ø630

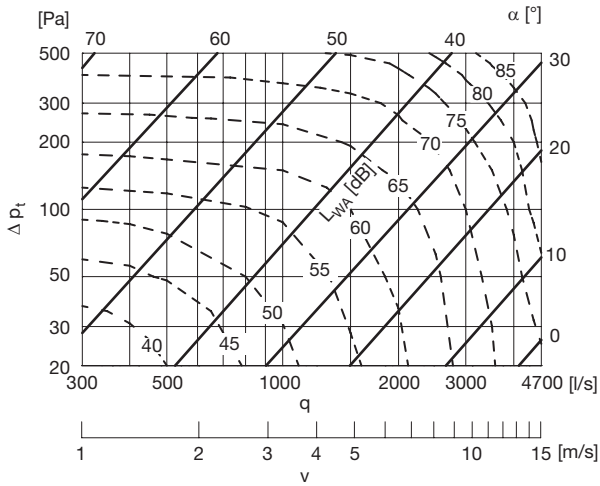

Ø900

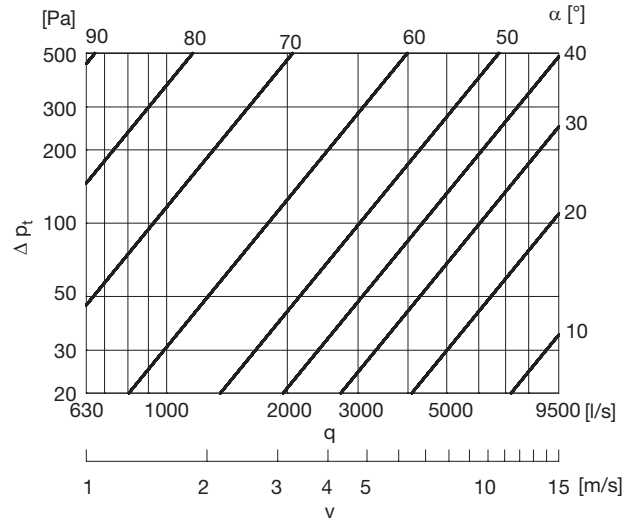

Ø710

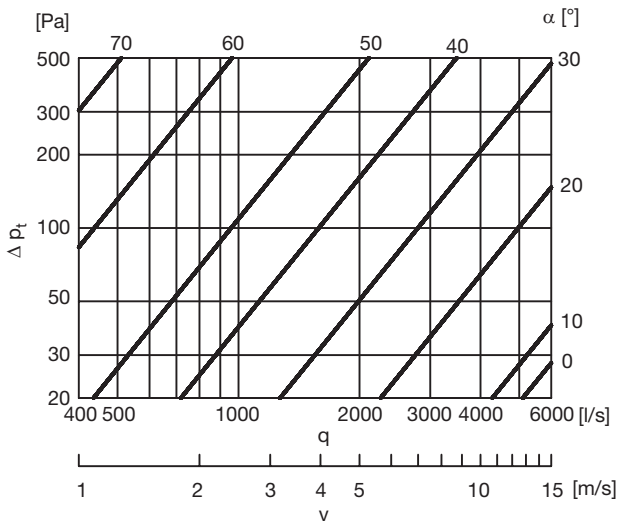

Ø1000

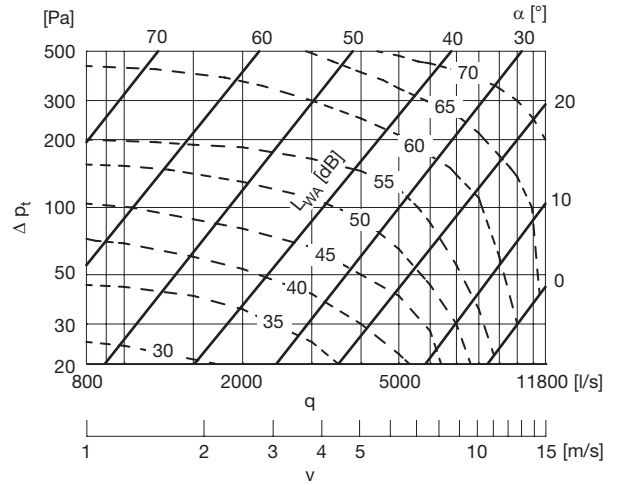

Ø800

